



Vue-More
 Turntables
We Put Your Designs in Motion

MB120

Part Number: 195120 021MB

Weight Capacity.....100 lbs [45kg]
 Standard RPM..... 2 Clockwise
 Torque Output @ 2 RPM.....32 in-lbs [3.62 Nm]
 Motor Draw..... 0.48 mA (58 mW)
 Shipping Weight.....4 lbs [1.8 kg]
 Power Cord.....6ft [2m]

Not Rated For Outdoor Use

PERFORMANCE TIPS

- Keep The Unit Level
- Keep The Weight As Centered As Possible

OPTIONS

- 1 RPM Clockwise
- 2 RPM Counter-Clockwise
- Masonite Top Plate Diameter.....8"/12"/17" [20cm, 30.5cm, 43cm]
- Steel Top Plate Diameter.....12"/17" [30.5cm, 43cm]

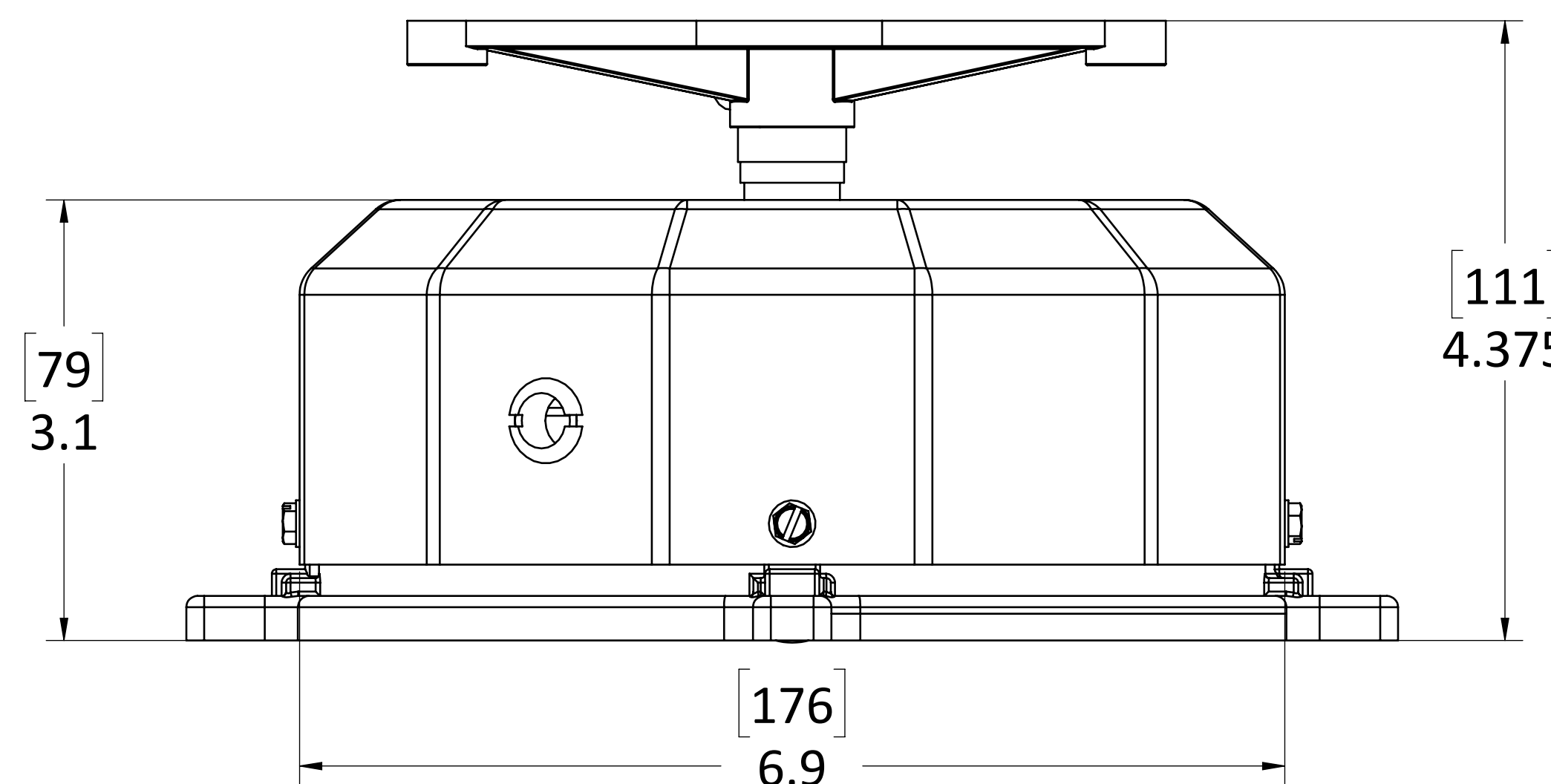
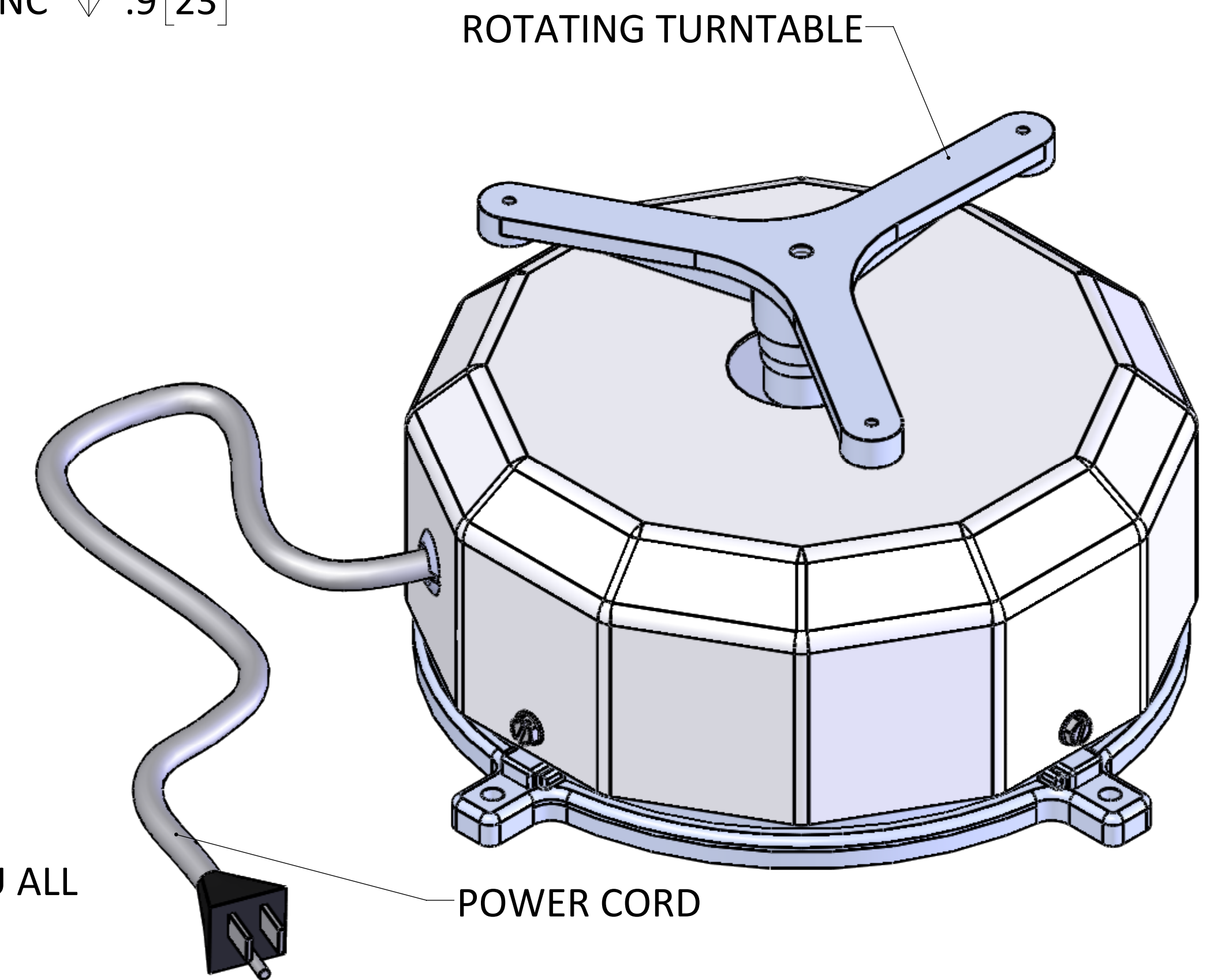
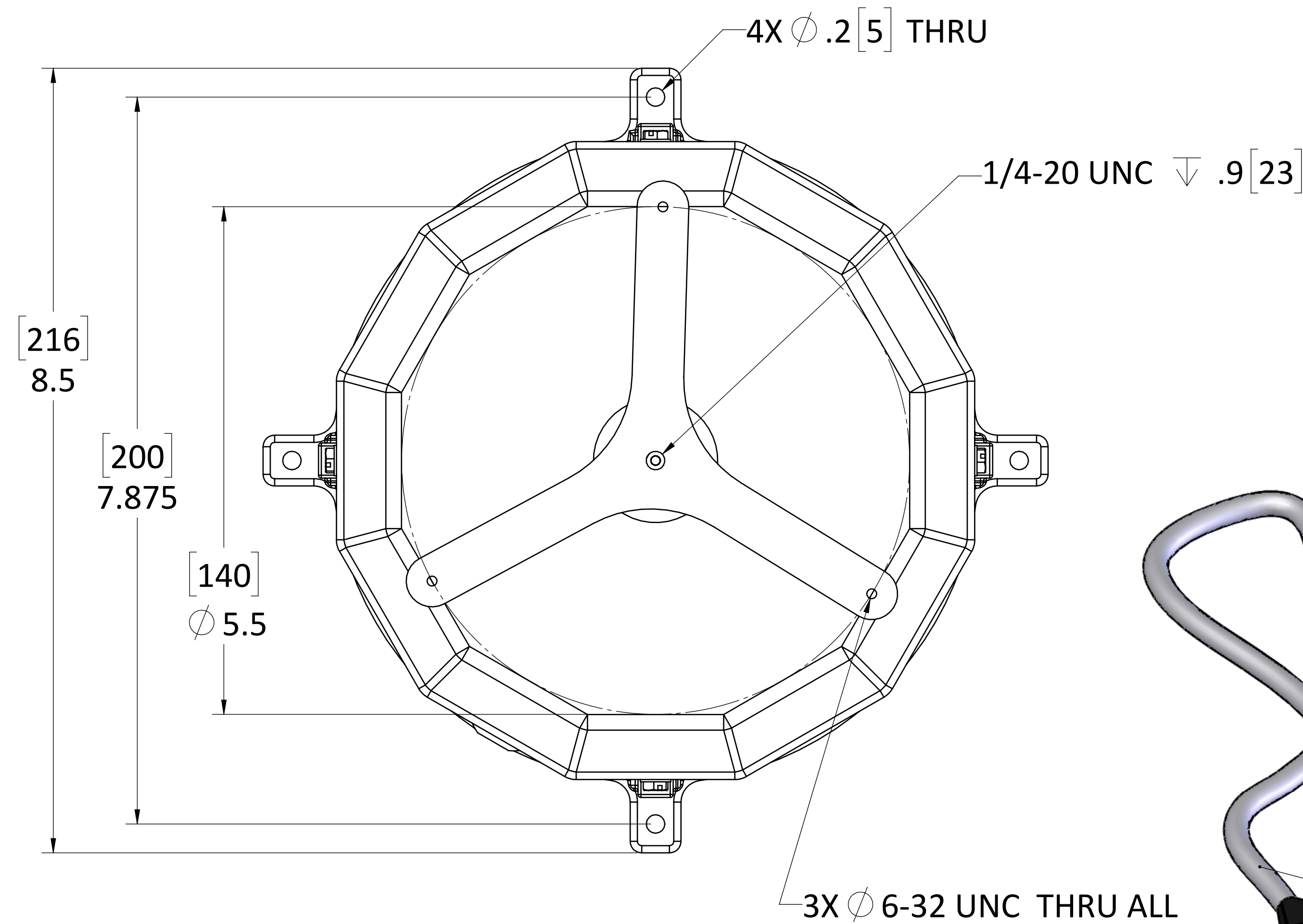

Vue-More powered by Dynapac Motion
 338 Hansen Ave., Salt Lake City, UT 84115
 Phone: 610-266-9600
 email: info@vuemore.com • www.vuemore.com