

**Step 1.** Attach left and right canopies using 6 **short** knobs and aluminum joining plate.

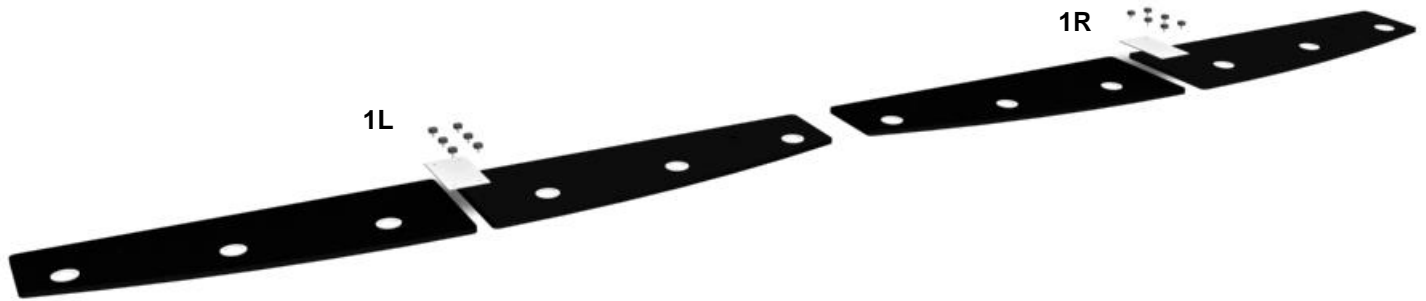

**Steps 2-4.** Flip canopy over and attach left and right upper column sections using 2 **short** knobs per column. Install gusset caps. **Step 4.** Attach header grippers.

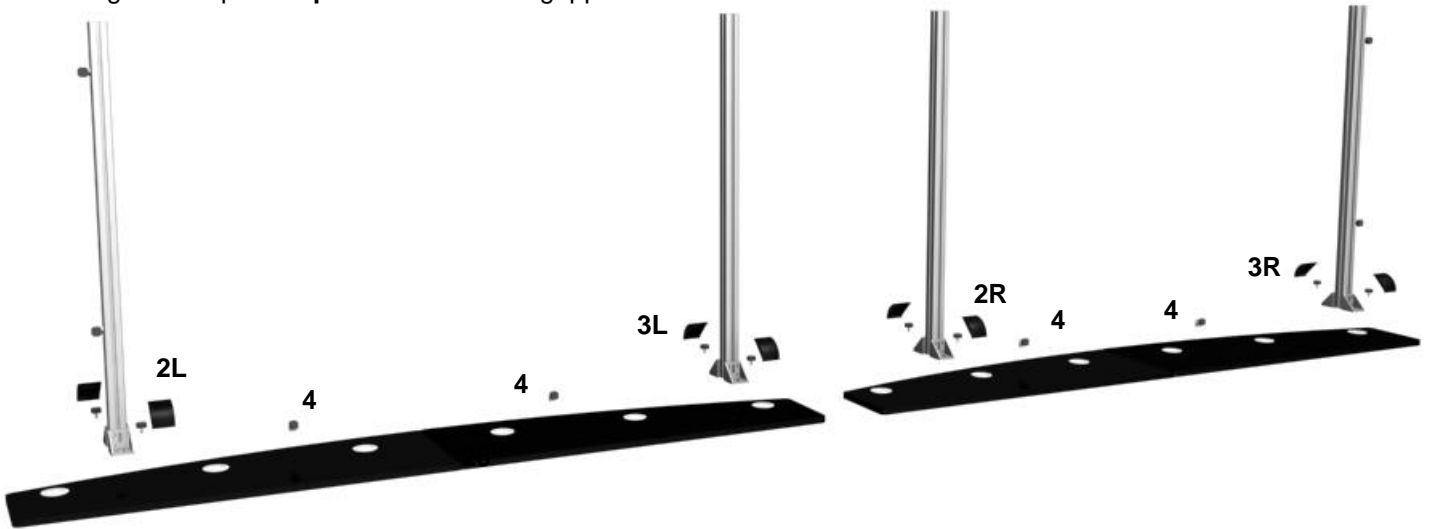

**Steps 5&6.** Attach left and right lower columns to feet using 2 **short** knobs per column. Install gusset caps.



**Steps 7&8.** Tip canopy and legs down; attach left and right lower columns to upper columns using 2 **short** knobs per column.

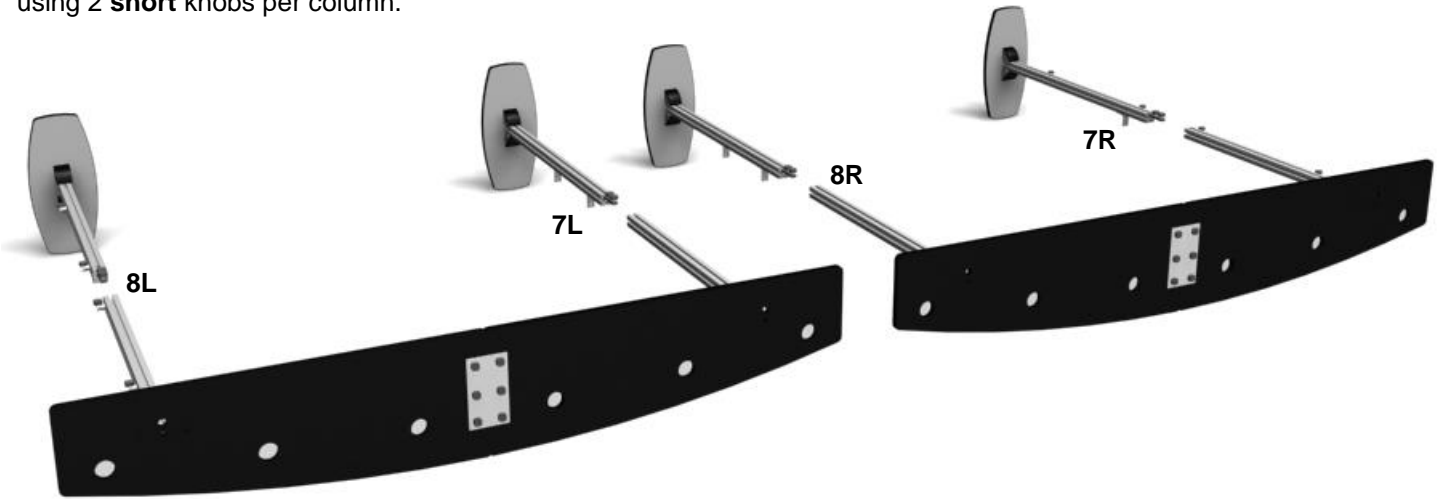

**Step 9.** Connect upper and lower graphic hangers. Slide upper and lower graphic hangers into graphic and hang graphic. Use metal slides to apply slight downward pressure on lower graphic hanger.

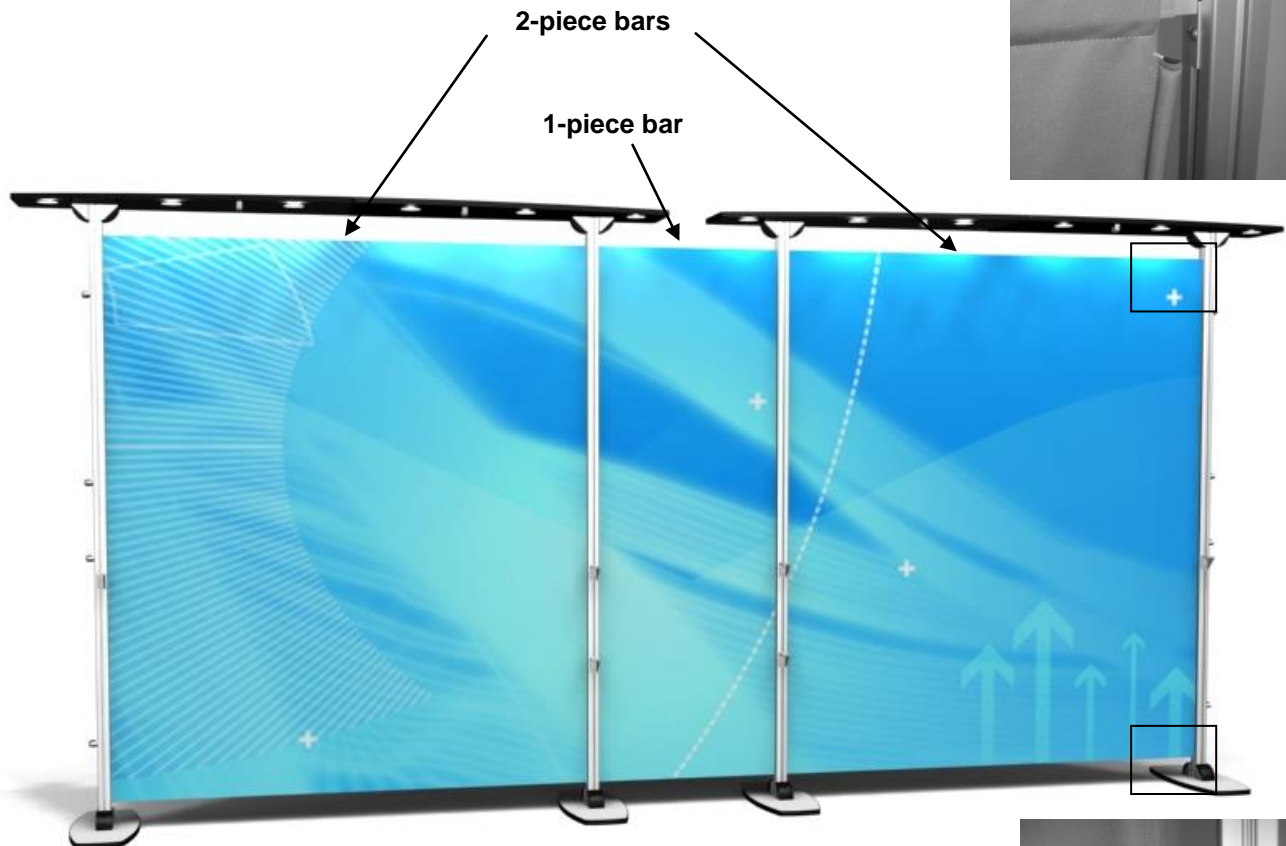

**Step 10.** Attach counter legs to counters using 2 **long** knobs per leg.

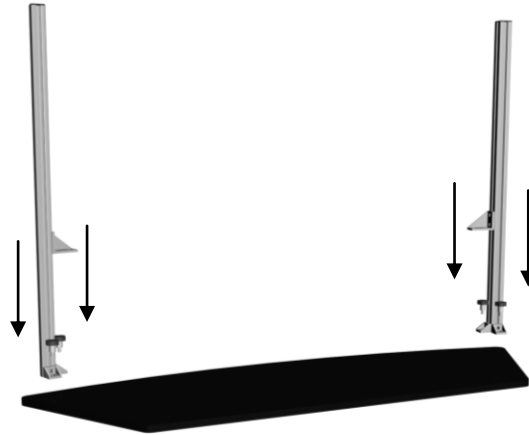

**Step 11.** Attach counter to columns from underneath using 2 **long** knobs.



**Step 12.** Attach shelf using 4 **long** knobs.

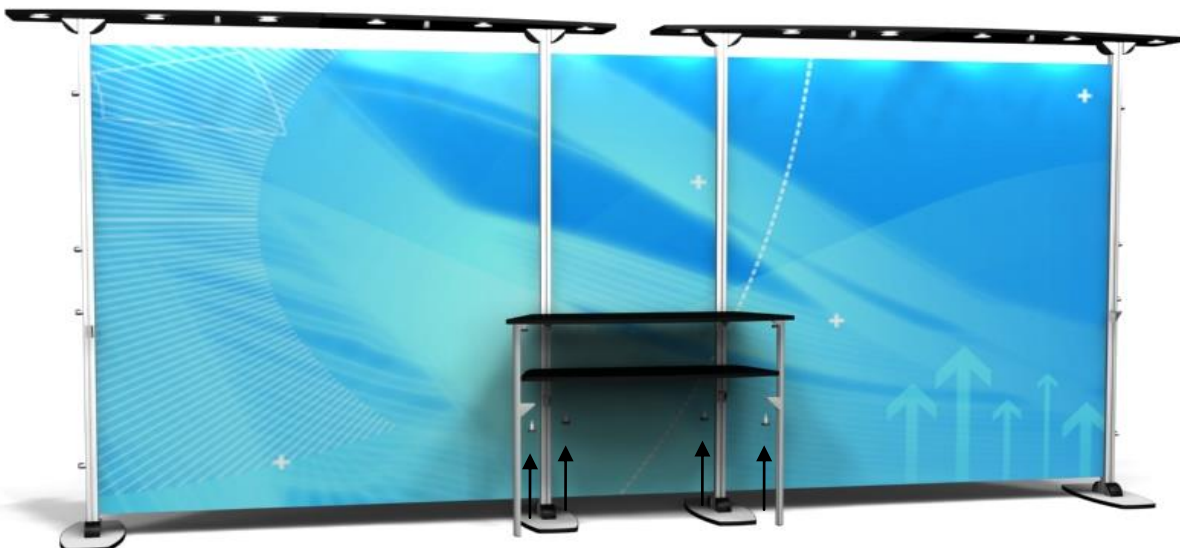

**Step 13.** Attach counter legs to counters using 2 **long** knobs per leg.

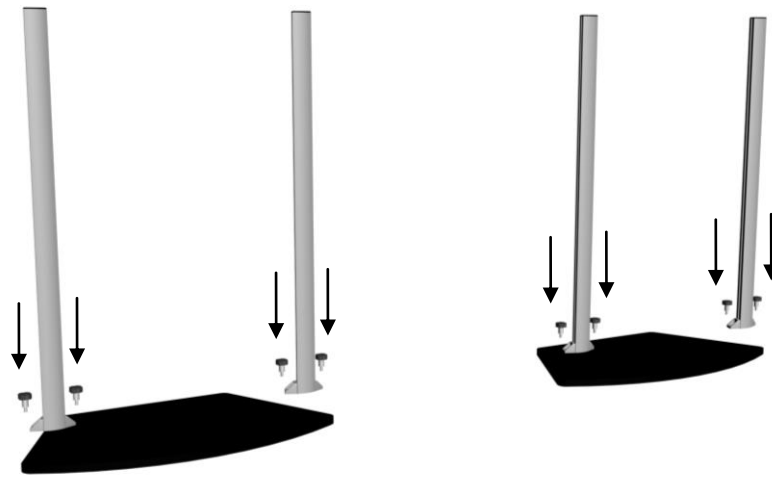

**Step 14.** Attach counters to backwall from underneath using one **long** knob per counter.



**Step 15.** Attach wings, headers & counter infill panels.

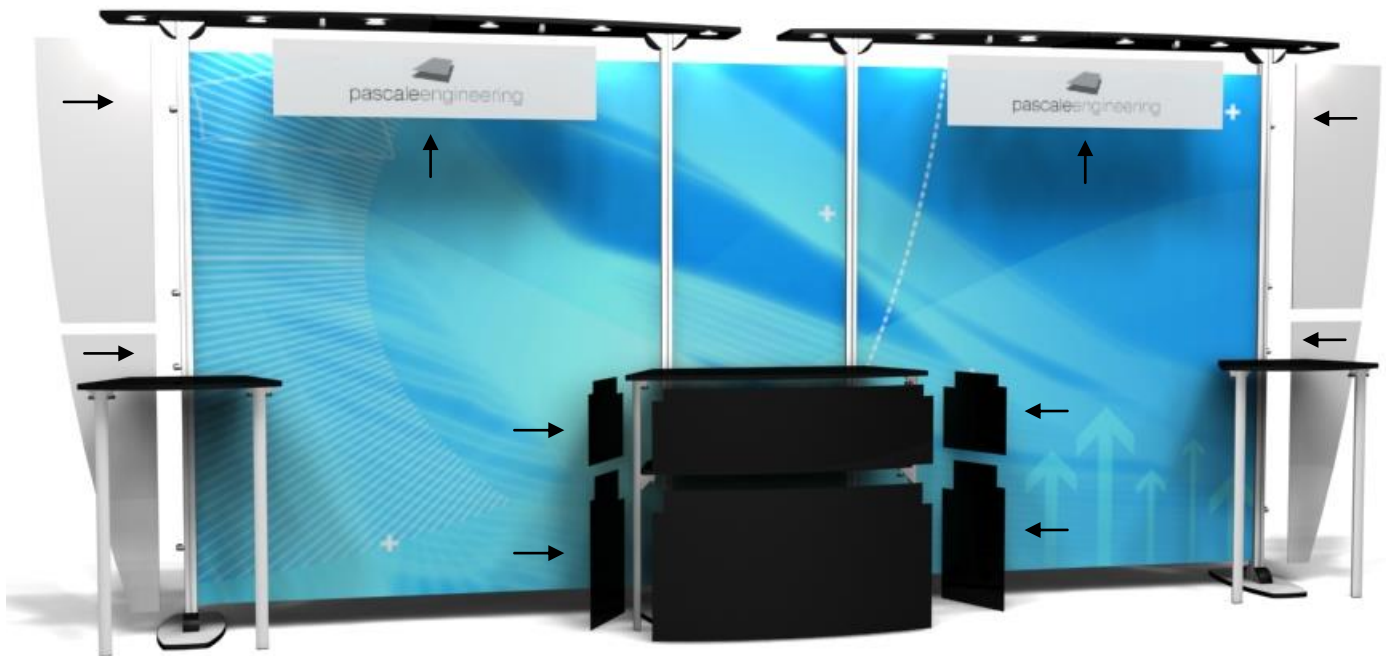

**Step 16.** Attach **optional** monitor mounts.

