

ORIGAMI SEG TRUSS INLINE B

PRODUCT CATEGORY: ORIGAMI TRUSS

PRODUCT CODE: ORIGAMI2010-B



On Frame

OnGraphic

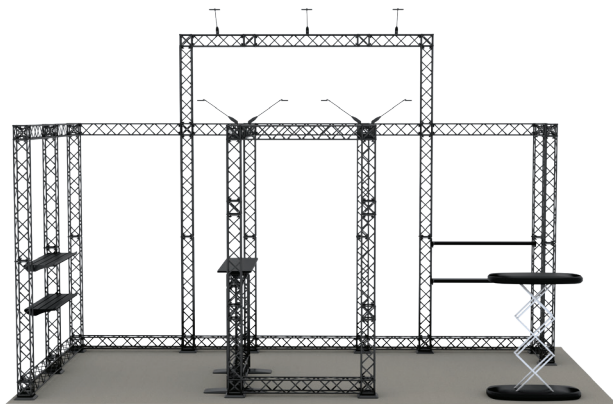

TRUSS FOLDED



TRUSS CUBE CONNECTOR



TRUSS FLAT CONNECTOR



SILICONE EDGE GRAPHICS

PRODUCT DESCRIPTION

Introducing the Origami Truss System – where innovation meets elegance. This cutting-edge 6in x 6in folding truss redefines the dynamics of display systems, offering a portable and sophisticated solution that outshines traditional truss systems in every aspect.

Key Features:

1. Portable Origami Design:

Unleash the power of portability with our Origami Truss System. Unlike conventional truss systems, this folding design ensures easy transportation and quick assembly without compromising on structural integrity.

2. Stunning Silicone Edge Graphics (SEG):

Elevate your brand presence with vibrant and flawless Silicone Edge Graphics (SEG). Choose between single or double-sided displays that can be seamlessly integrated between the truss frame or fully wrapped around, ensuring your message captivates from all angles.

3. Tailored Configurations:

Empower your brand with flexibility. Select from our library of standard configurations for a swift setup or let your creativity shine by designing a custom configuration that aligns perfectly with your unique brand identity and display requirements.

4. Comprehensive Accessories:

Illuminate your brand with a range of accessories crafted for both functionality and visual allure. Enhance your presentation with monitor mounts for interactive experiences, LED lights strategically positioned for front-lit graphics, shelving for product displays, slat walls for additional customization, and counters that invite engagement.

The Origami Truss System is more than a display solution; it's a canvas for your brand story. Whether you're an industry veteran or a newcomer, make a lasting impression with a truss system that seamlessly blends innovation, portability, and customization. Elevate your brand presence with Origami – because your brand deserves a display as unique as its story.

DISPLAY DIMENSIONS	227.75"W x 150.3"H x 118"D
GRAPHIC SIZES	See Template Guide

GRAPHIC MATERIAL

Dye Sublimated Black & White Fabric

GRAPHIC FINISHING

12mm x 3mm silicone beading is sewn around the perimeter of the fabric graphic. Silicone beading is hidden from view once installed.

DISPLAY CONSTRUCTION

Iron truss construction with durable black plastic coating

ORIGAMI SEG TRUSS INLINE B

PRODUCT CATEGORY: ORIGAMI TRUSS

PRODUCT CODE: ORIGAMI2010-B



On Frame

OnGraphic

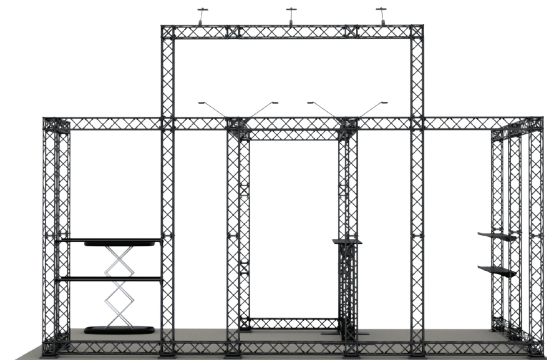
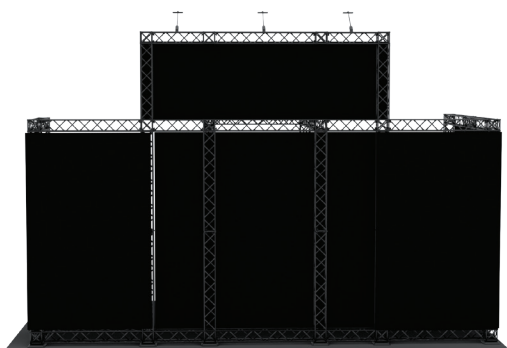
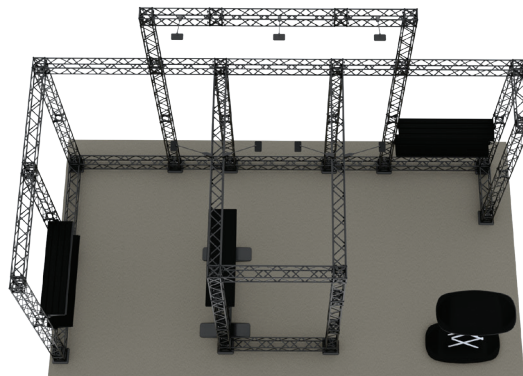
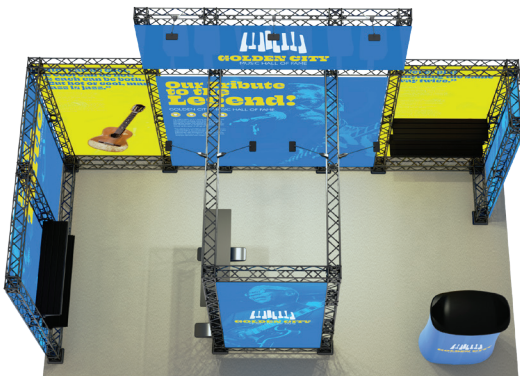
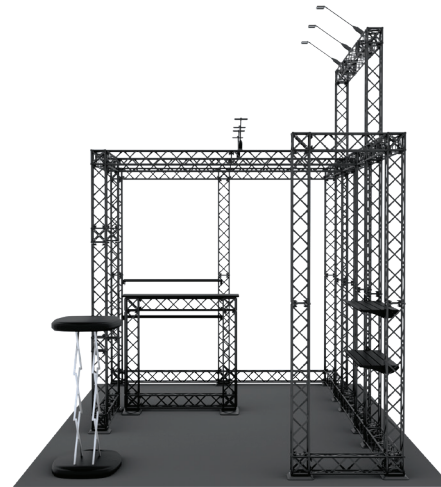
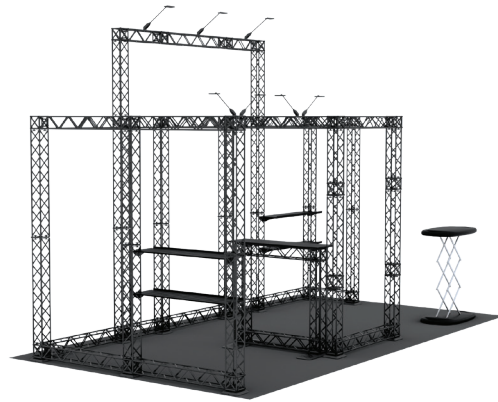
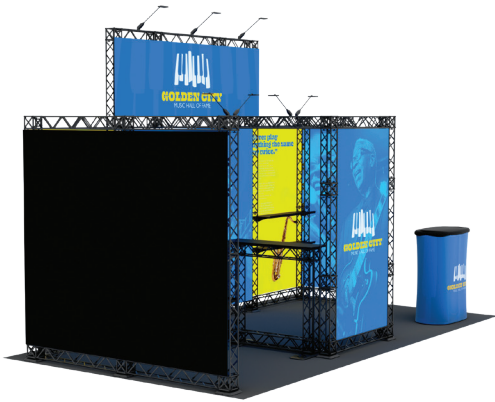

ORIGAMI SEG TRUSS INLINE B

PRODUCT CATEGORY: ORIGAMI TRUSS

PRODUCT CODE: ORIGAMI2010-B



On Frame

OnGraphic

PARTS LIST

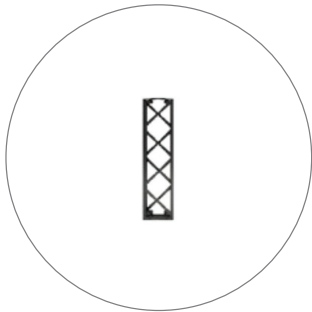

(qty 14) Truss 60cm Length
TRUSS-60CM

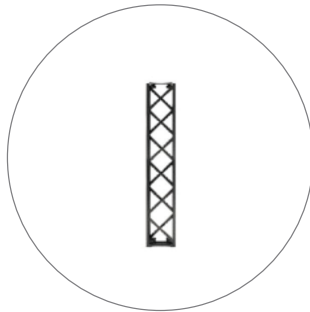

(qty 8) Truss 90cm Length
TRUSS-90CM

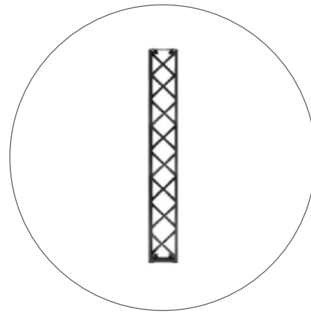

(qty 35) Truss 120cm Length
TRUSS-120CM



(qty 32) Truss Cube Connector
TRUSS-CUBE



(qty 11) Truss Flat Connector
TRUSS-FLAT



(qty 50) Truss SEG Channel
TRUSS-SEG-S



(qty 11) Truss Foot Small
TRUSS-FT-S



(qty 1) Truss Foot Large
TRUSS-FT-L

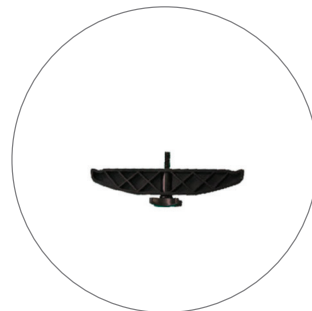

(qty 4) Truss Lightbox Connector
TRUSS-LB-CON

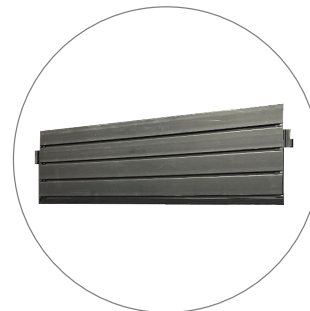

(qty 8) Truss Slatwall
TRUSS-SLAT

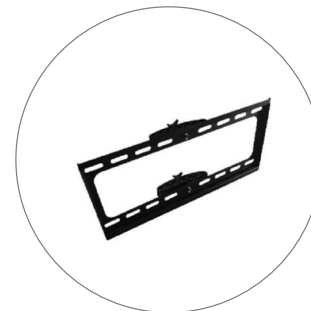

(qty 1) Truss Monitor Mount
TRUSS-MM



(qty 1) Lightbox



(qty 1) Gopher Pop Up Counter
GOPP



(qty 10) Truss LED Light
w/Brackets
TRUSS-LIGHT
TRUSS-LAMP-BASE



(qty 1) Drill Kit (2 Drills + Bag)
TRUSS-DRILL



On Frame

OnGraphic

SHIPPING DIMENSIONS

L"	W"	H"	LBS	BOX QTY
25.74	12.87	13.26	26.62	2
37.44	12.87	13.26	36.96	1
49.14	12.87	13.26	47.3	6
6.63	6.63	6.63	2.86	1
25.74	12.87	13.26	42.02	2
33.15	17.16	15.21	61.16	1
37.44	13.26	7.8	5.94	4
60.84	12.87	13.26	63.8	1
34.32	21.45	6.24	28.6	1
TOTALS			556.38	19

ORIGAMI SEG TRUSS INLINE B

PRODUCT CATEGORY: ORIGAMI TRUSS
PRODUCT CODE: ORIGAMI2010-B



On Frame OnGraphic

TEMPLATE & GRAPHIC INSTALL GUIDE

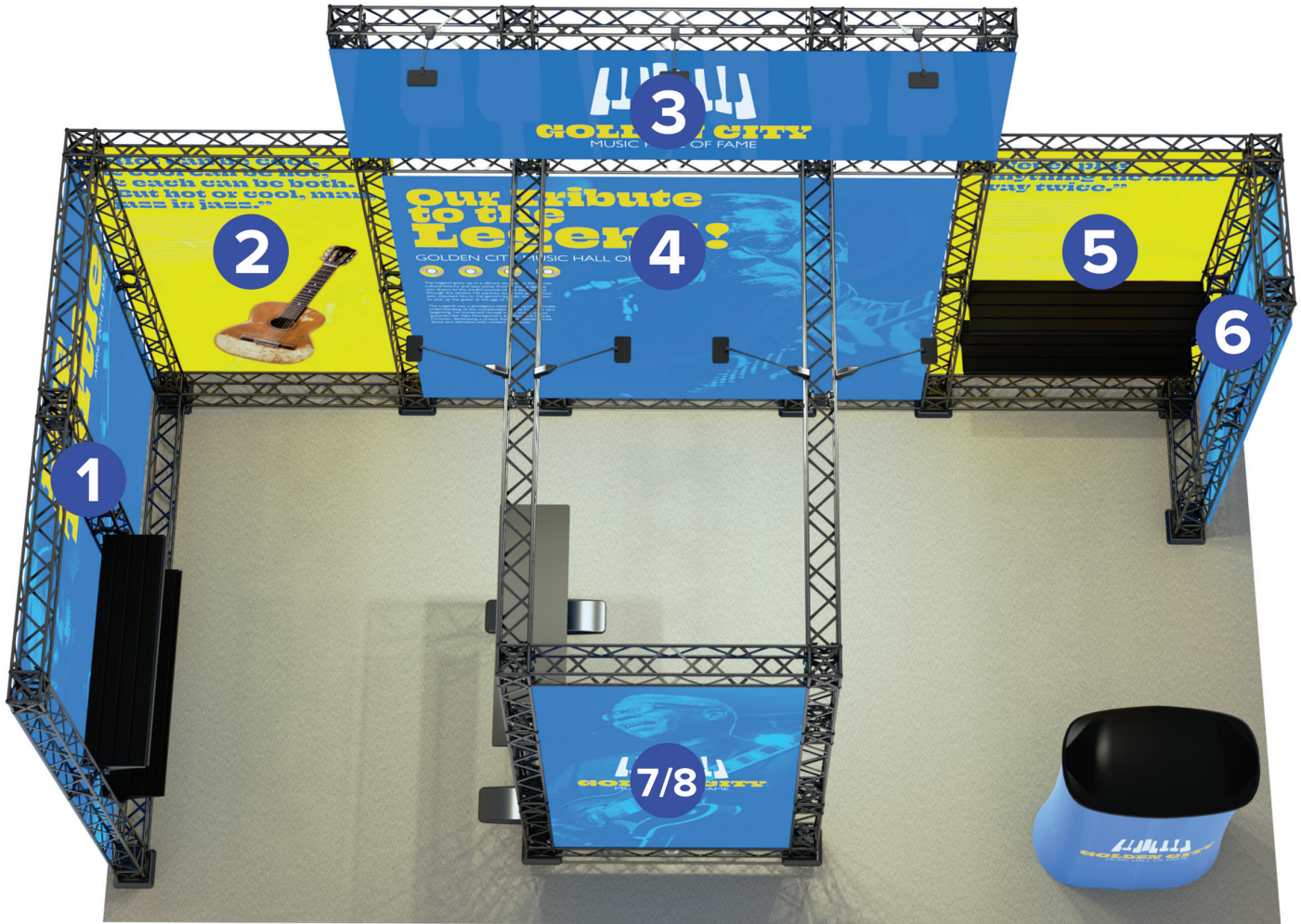

1. REVERSE MOUNT (SPANS BOTH FRAMES)
2. REVERSE MOUNT
3. FRONT MOUNT (TOP HEADER)
4. FRONT MOUNT

5. REVERSE MOUNT (BEHIND SHELVING)
6. REVERSE MOUNT
7. FRONT MOUNT (FRONT - TRUSS)
8. FRONT MOUNT(BACK - LIGHTBOX)

FRONT MOUNT: GRAPHIC INSTALLS ON FRONT OF FRAME

REVERSE MOUNT: GRAPHIC INSTALLS ON BACKSIDE OF FRAME W/GRAPHIC FACING FORWARD

NUMBERS ON THE IMAGE ABOVE INDICATE THE TEMPLATE LOCATION # ON FRAME
PLEASE ADD TEMPLATE LOCATION # TO END OF FILENAME. EX: "ORIGAMI2010-B-1 "

ORIGAMI SEG TRUSS INLINE B

PRODUCT CATEGORY: ORIGAMI TRUSS
PRODUCT CODE: ORIGAMI2010-B



On Frame

OnGraphic

SET UP INSTRUCTIONS

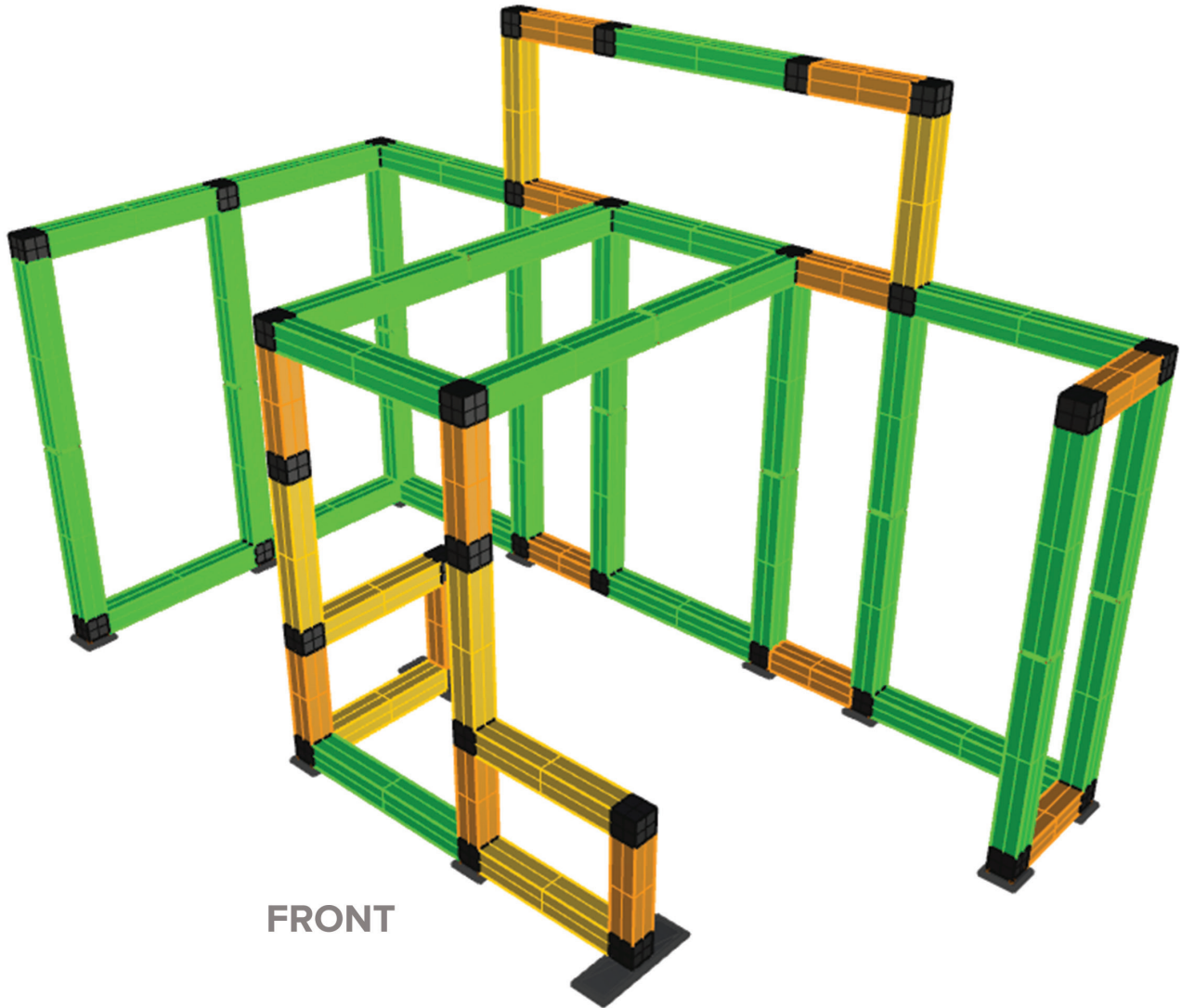







FRONT



BACK

TRUSS LENGTH COLOR KEY

-   TRUSS-60CM
-   TRUSS-90CM
-   TRUSS-120CM



SET UP INSTRUCTIONS CUBE CONNECTOR

TRUSS-CUBE

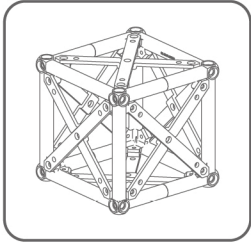

TRUSS

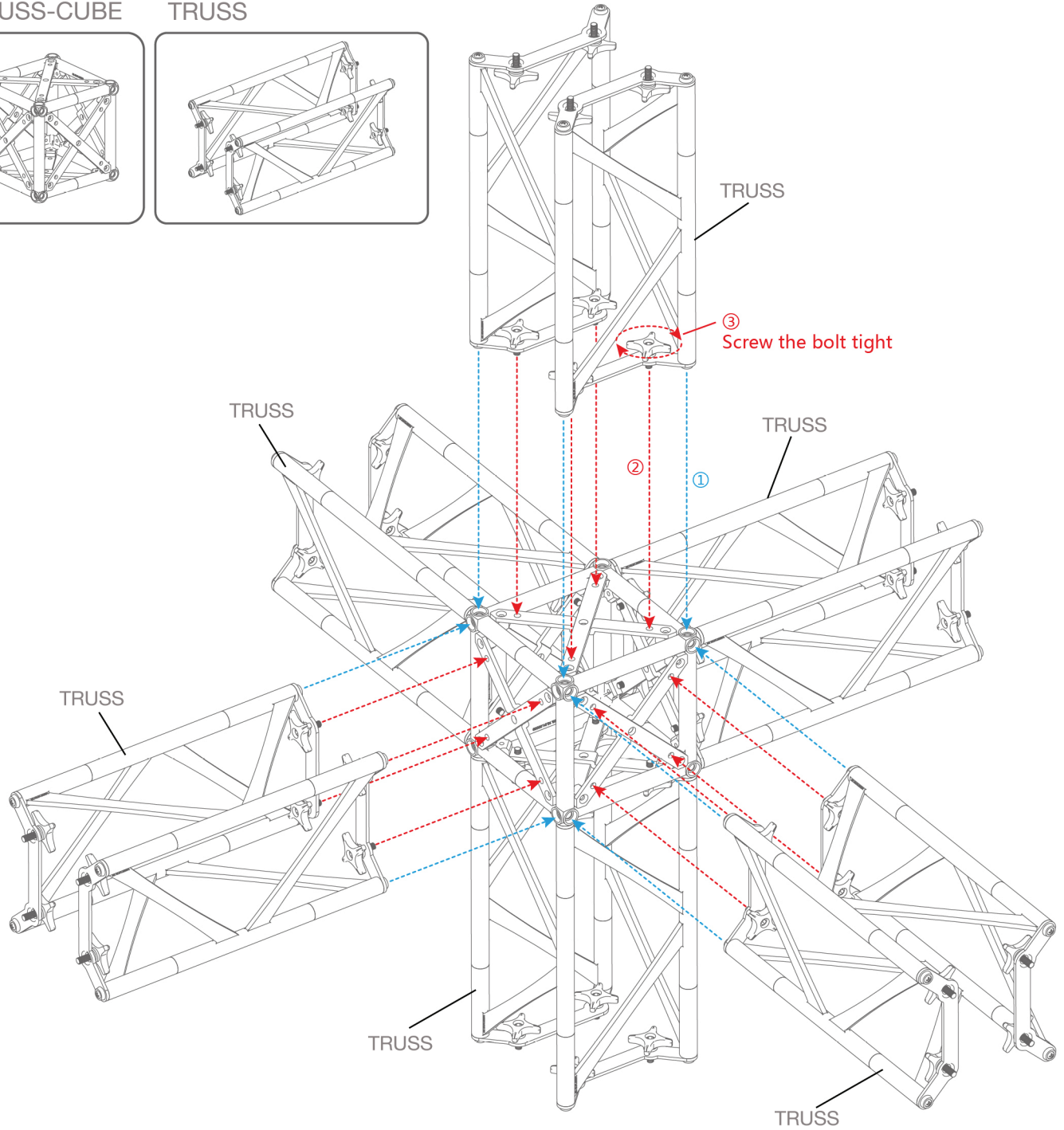
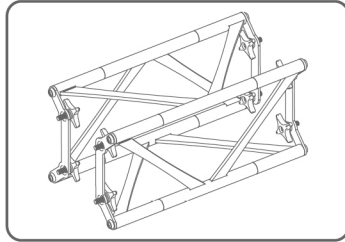

ORIGAMI SEG TRUSS INLINE B

PRODUCT CATEGORY: ORIGAMI TRUSS

PRODUCT CODE: ORIGAMI2010-B



On Frame

OnGraphic

SET UP INSTRUCTIONS FLAT CONNECTOR

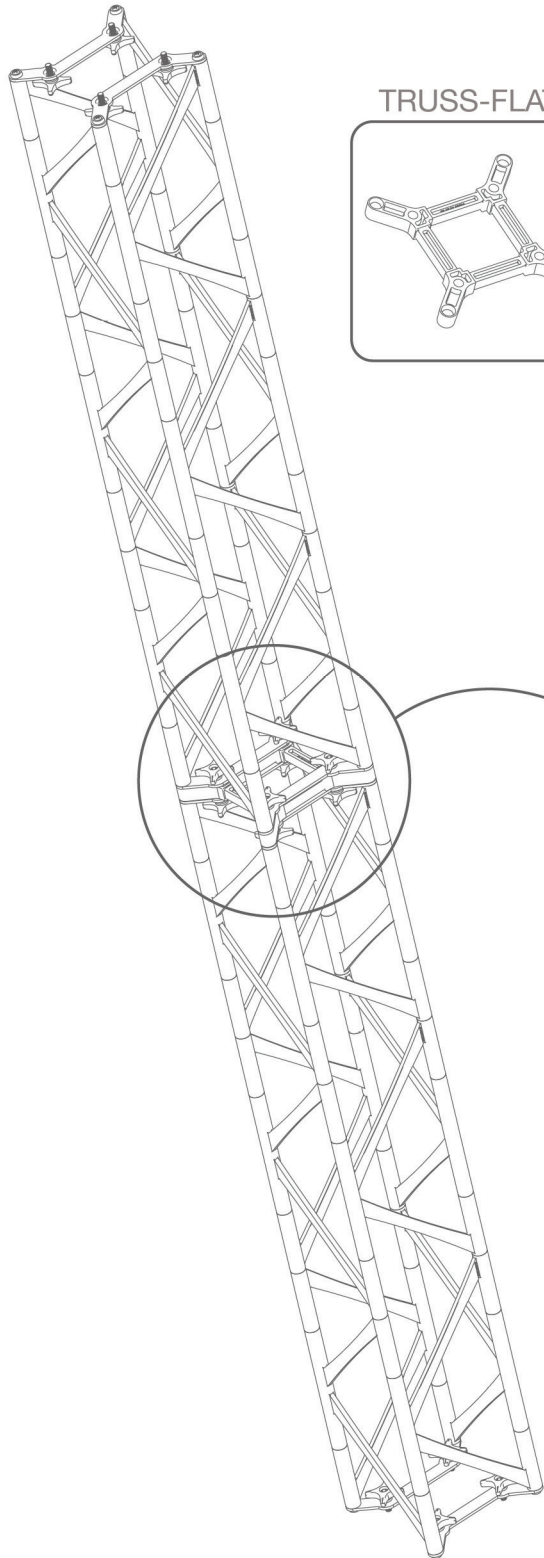

TRUSS-FLAT

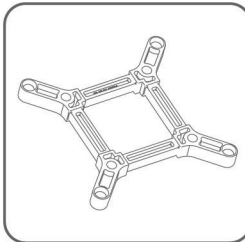

TRUSS

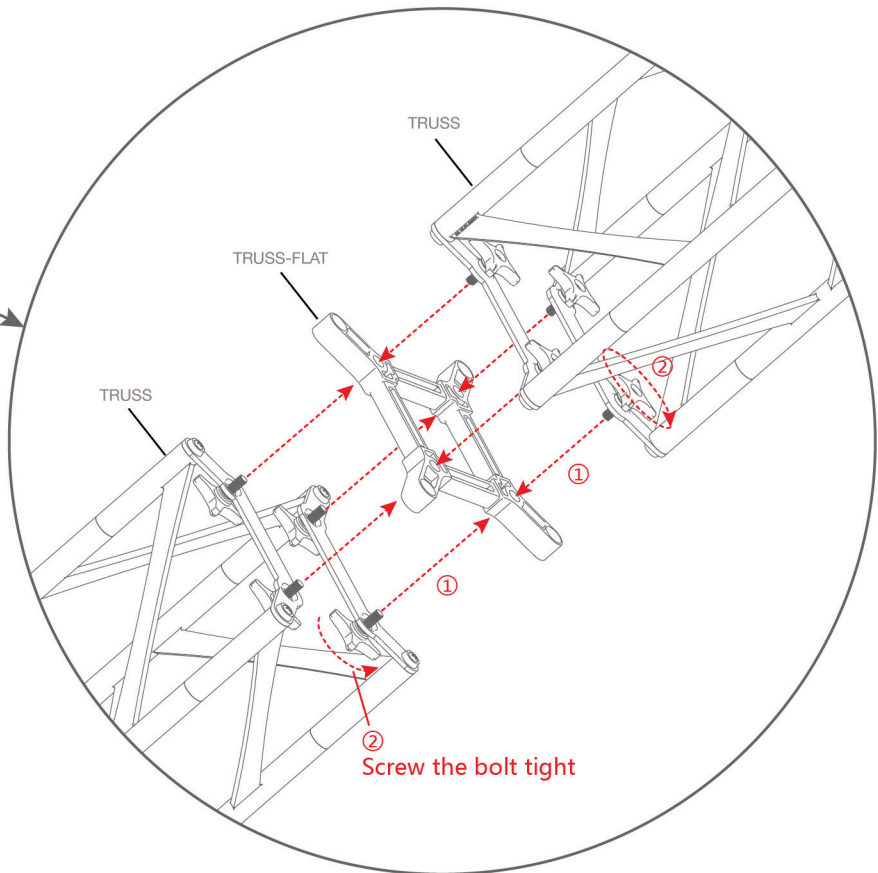
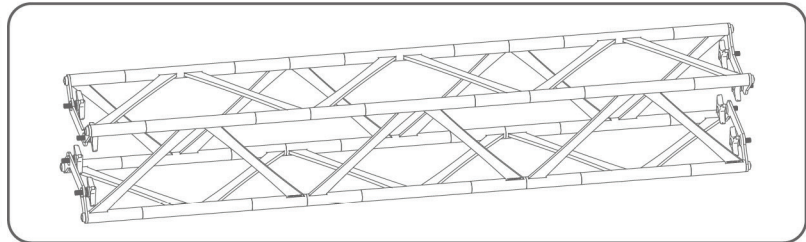

SET UP INSTRUCTIONS SEG CHANNELS

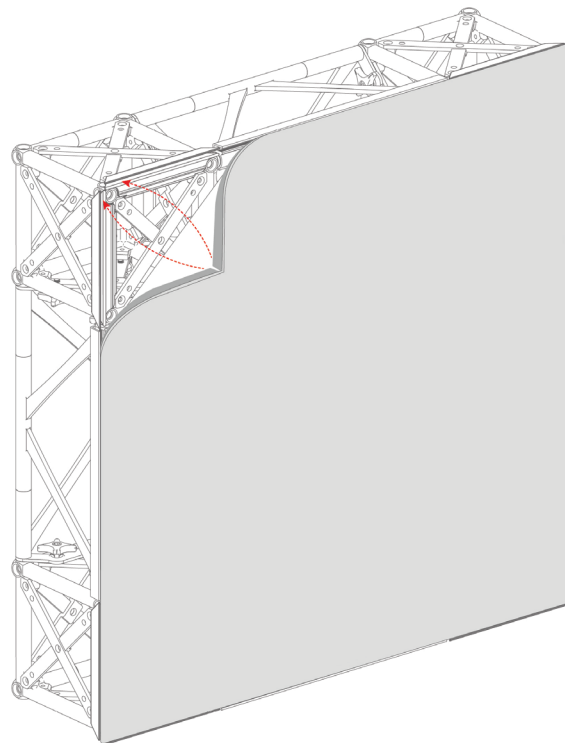
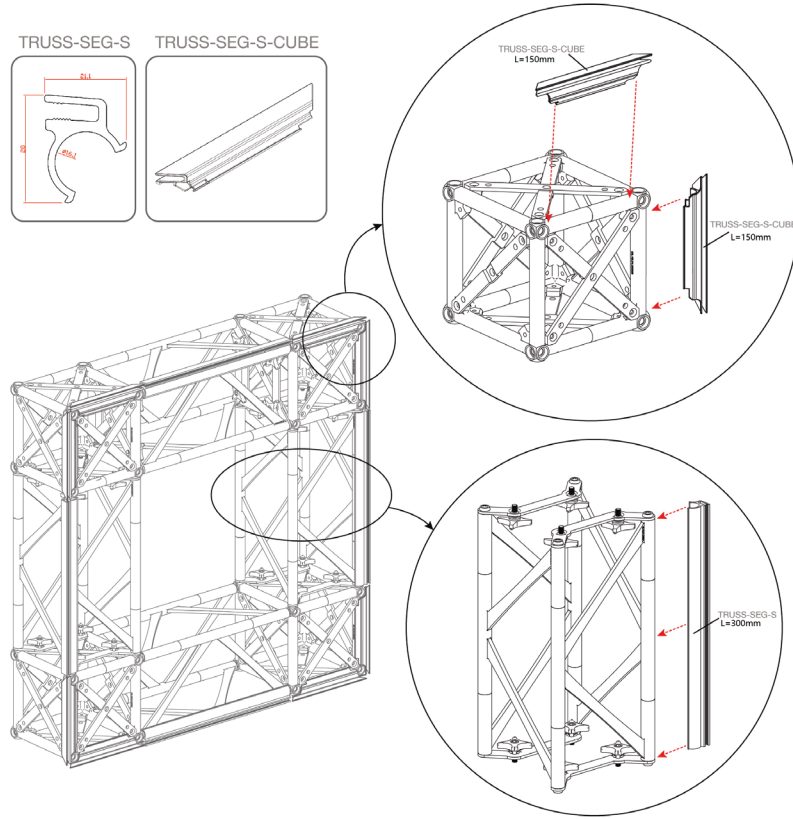

SET UP INSTRUCTIONS SLAT WALL & SHELVES

TRUSS-SLAT

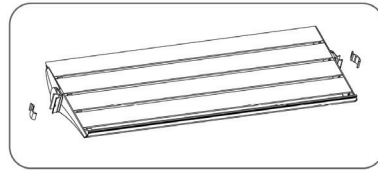

Step 1

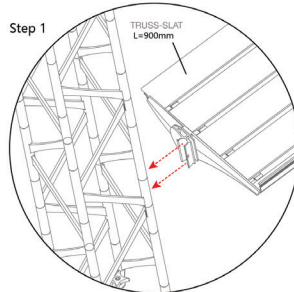

Step 2

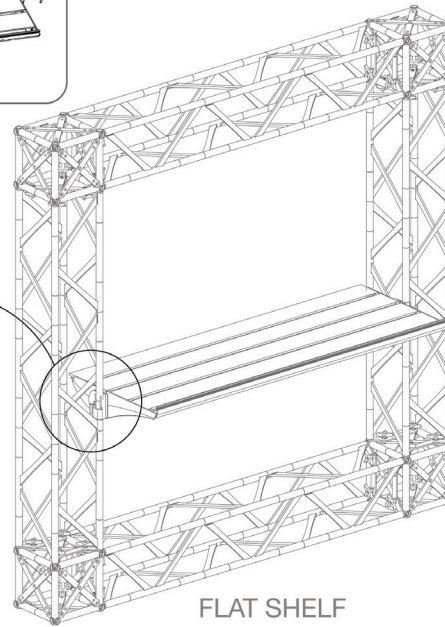
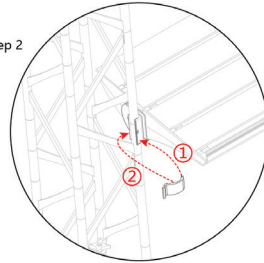

FLAT SHELF

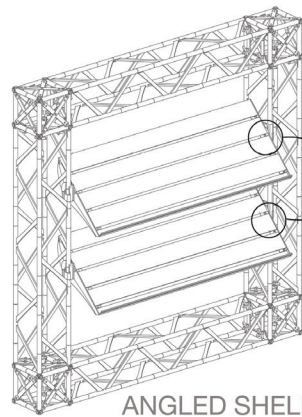

ANGLED SHELF

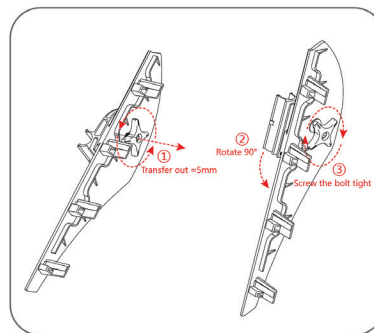
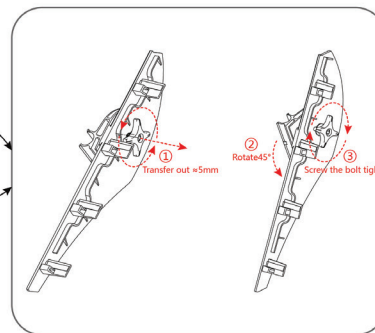

SLATWALL