

WAVELINE®  
**COUNTERS**

# WLC-H-S1

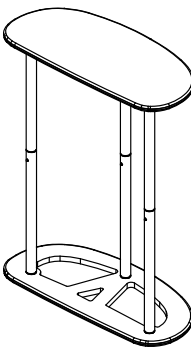
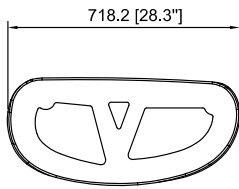
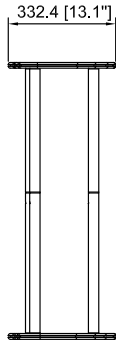
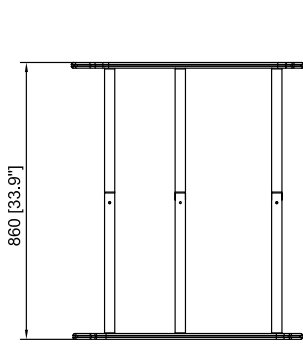

Hardware										Countertop			Graphics		Accessories			Shipping Case				
No.	Quantity	Confirm	No.	Quantity	Confirm	No.	Quantity	Confirm	No.	Quantity	Confirm	Yes / No		Single -sided	None		Complete		Split-ship		WLC-P-BG	
WLC-H-S1	1																					

# WLC-H-S2

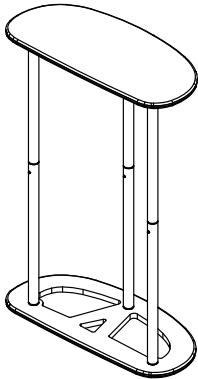
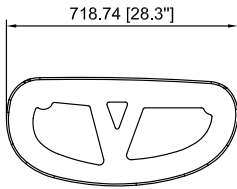
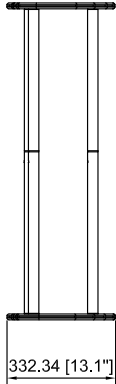
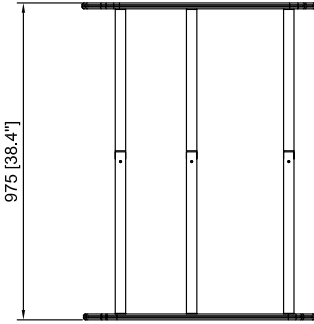

Hardware										Countertop			Graphics		Accessories			Shipping Case									
No.	Quantity	Confirm	/							No.	Quantity	Confirm	Yes / No		Single -sided					WLC-P-BG							
										No.	Quantity	Confirm	No.	Quantity	Confirm	No.	Quantity	Confirm	None								
										No.	Quantity	Confirm	No.	Quantity	Confirm	No.	Quantity	Confirm	Complete								
										No.	Quantity	Confirm	No.	Quantity	Confirm	No.	Quantity	Confirm	Split-ship								
WLC-H-S2	1		/										Yes / No		Single -sided					WLC-P-BG							
										No.	Quantity	Confirm	No.	Quantity	Confirm	No.	Quantity	Confirm	None								
										No.	Quantity	Confirm	No.	Quantity	Confirm	No.	Quantity	Confirm	Complete								
										No.	Quantity	Confirm	No.	Quantity	Confirm	No.	Quantity	Confirm	Split-ship								

# WLC-H-M1

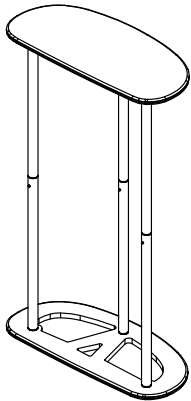
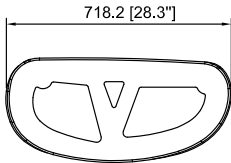
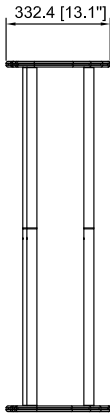
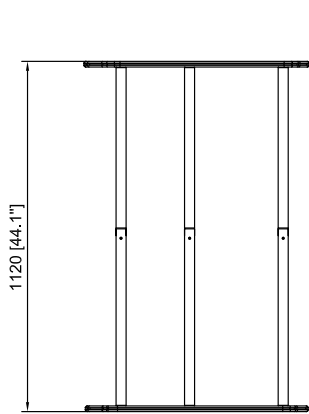

Hardware										Countertop			Graphics		Accessories			Shipping Case		
No.	Quantity	Confirm				No.	Quantity	Confirm	No.	Quantity	Confirm		Confirm	No.	Quantity	Confirm	No.	Quantity	Confirm	
WLC-H-M1	1											Yes / No	Single -sided				WLC-P-BG			
													None							
													Complete							
													Split-ship							

# WLC-H-M2

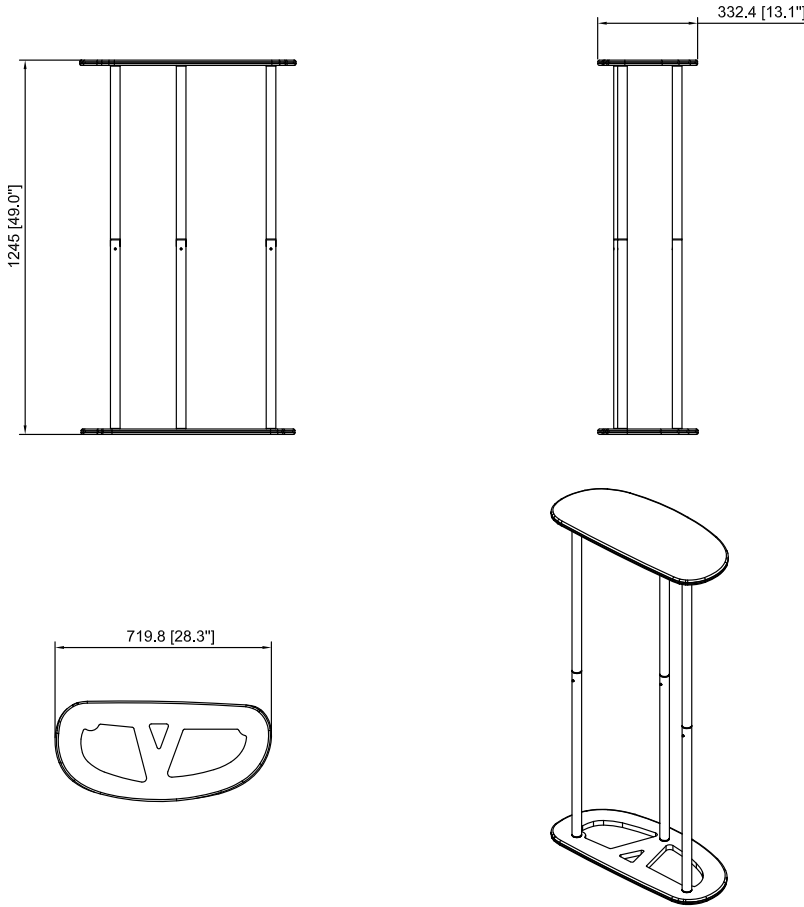

Hardware										Countertop			Graphics		Accessories			Shipping Case			
WLC-H-M2	1									Yes / No			Single -sided					WLC-P-BG			
													None								
													Complete								
													Split-ship								
No.	Quantity	Confirm				No.	Quantity	Confirm	No.	Quantity	Confirm	No.	Quantity	Confirm		No.	Quantity	Confirm	No.	Quantity	Confirm

# WLC-H-L1

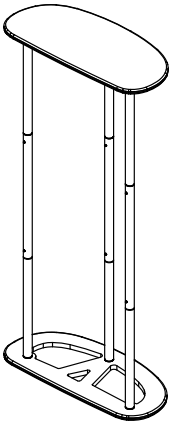
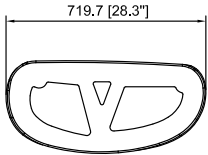
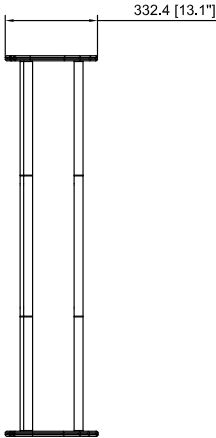
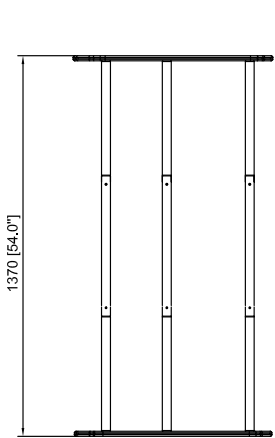

Hardware										Countertop			Graphics		Accessories			Shipping Case		
WLC-H-L1	1									Yes / No			Single -sided					WLC-P-BG		
													None							
													Complete							
													Split-ship							
No.	Quantity	Confirm				No.	Quantity	Confirm	No.	Quantity	Confirm	No.	Quantity	Confirm	No.	Quantity	Confirm	No.	Quantity	Confirm

# WLC-H-L2

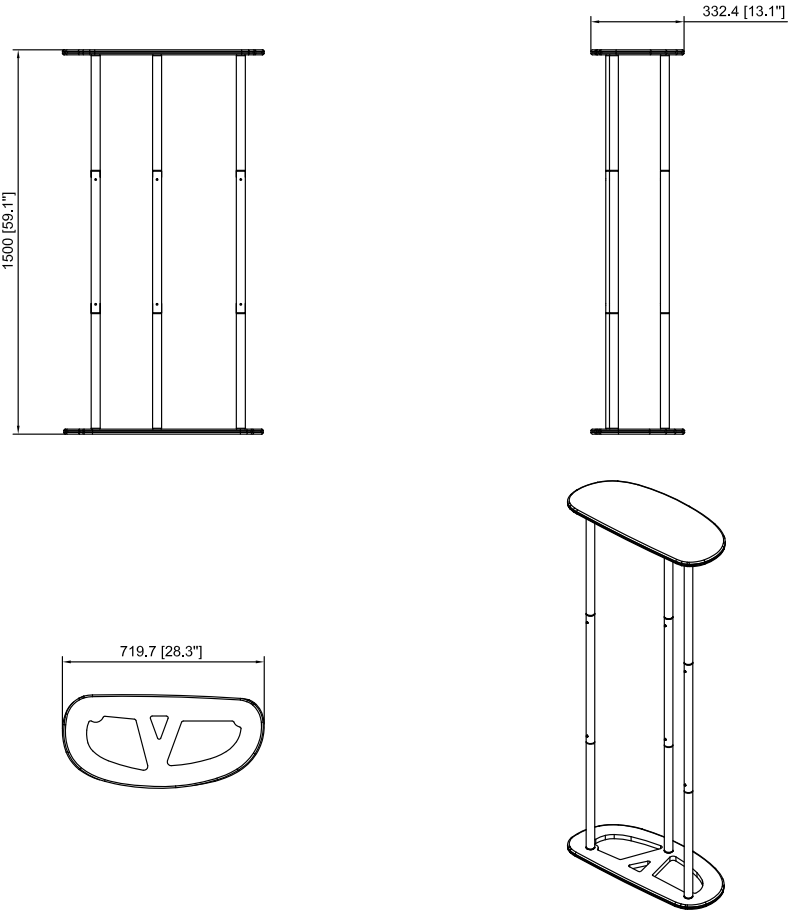

Hardware										Countertop			Graphics		Accessories			Shipping Case			
WLC-H-L2	1									Yes / No			Single -sided					WLC-P-BG			
													None								
													Complete								
													Split-ship								
No.	Quantity	Confirm				No.	Quantity	Confirm	No.	Quantity	Confirm	No.	Quantity	Confirm		No.	Quantity	Confirm	No.	Quantity	Confirm